

Hose clamp



Suzhou Baotailong Electronic Materials Co., Ltd.
Room 1206, Jinhe International Building, No. 35 Shishan Road,
Huqiu District, Suzhou, Jiangsu, China
<https://www.btektech.com/>











Tel: (+86) 18706202541

Email: rita@btektech.com

Directory

Directory -----	P01
Product Guide -----	P/02
Safety Sealing Technology -----	P/03
American Hose Clamp -----	P/04
German Hose Clamp -----	P/05- 06
British Hose Clamp -----	P/07
Spring Clamp -----	P/08
Single Ear Clamp/ Double Ear Clamp -----	P/09-10
European Strength /T Strength -----	P11
Steel Wire Strong Hose Clamp -----	P12
Tape and Bundle Clamp -----	P13
Installation Tools and Other Clamps -----	P14
Clamp Weight and Packaging Size -----	P15

Product Guide

Specific ation Product name	Spring steel/carbon steel 65MnW1	Ordinary stainless steel semi-steel W2	Stainless steel 201/304 all steel W2	Acid-resistant stainless steel 316 W5	Product features
American diameter 8-infinite					Any length, can be round and square, be called a universal clamp
British Diameter 8-200mm					Enhance the leak-proof protection of the hose
German Diameter 8-300mm		 12mm 9mm	 12mm 9mm		Can effectively ensure that the surface of the silicon hose is not damaged.
European strength diameter 13-400mm					Has strong fastening force and prevent damage
Single ear clamp diameter 5.5-150mm					Easy to install, 360-degree infinite sealing
Spring clamp diameter 6.5-40mm					Fast installation and low cost
Double steel wire clamp diameter 11-1000mm					Small contact surface and strong fastening force
Tape clamp Diameter 6-120mm					Reduce the damage to wires and hoses due to vibration
Hanger clamp diameter 25-200mm					Can fasten and connect the steel pipe

Safety sealing and fastening technology

Firm and reliable:

Our hose clamp has anti-vibration and anti-loose performance. The perfect engagement of turbine vortex rod can make strong and reliable sealing ability of clamp around the hose.

Product development:

In our research and development center, researchers are constantly improving products to provide you with higher quality, more efficient and longer-lasting sealing and fastening products!

High fastening force:

Clamps with high roundness should be able to produce a uniform and strong fastening force around the hose or hard tube, so as to produce a lasting and effective seal on the bundled logistics. According to the torque, you can select the appropriate pressure for application.







Guarantee no leakage:

The hose clamp shall have different performance for different occasions and different products. Our traditional turbine steel belt throat hoop is widely used because of its large adjustment range, large contact area and accurate torque. Our fast-mounting single ear hose clamp is used in places requiring higher air tightness such as the engine due to its huge clamping force and strong anti-destructive property. Please select Our hose clamp for your work efficiency and safety.

Environmentally friendly materials:

In response to the concept of green and environmental protection, Our hose clamp select all environmentally friendly materials for the production of clamps. Stainless steel clamps and environmentally friendly galvanized products have been certified by international authorities for many times!

Layer -by-layer inspection from incoming material to finished product delivery

Raw material inspection	Torque test	Salt spray test	Environmental protection test	Factory qualification inspection	Material warranty
					

Our process

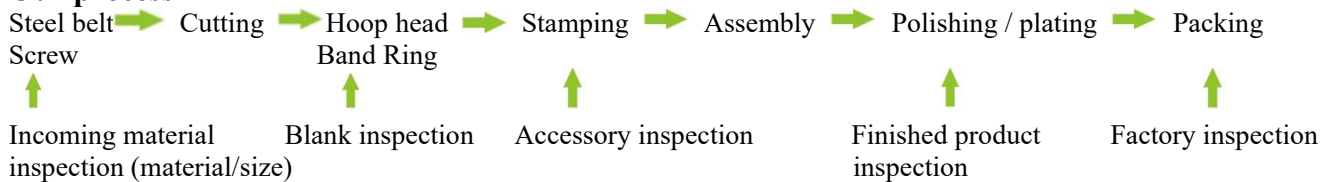

Five procedures control, make sure everything is in order, a procedure is unqualified, so the procedure starts again!

NOTE: Turbine vortex rod is a staggered transmission of two axial forces, which has the characteristics of large transmission torque and stable operation.

American Hose Clamp Turbine and vortex rod hose clamp series

Note: The following table, American, German, British and powerful are universal.

Model	W1	W2	W3	W4	W4	W5
Steel strip material	Carbon steel	Stainless steel	All 430 stainless steel Chromium-containing stainless steel	All 201 stainless steel Low nickel	All 300 series stainless steel N18%	All stainless steel 316 NI: 10%
Hoop material	Carbon steel	Stainless steel				
Screw	Carbon steel	Carbon steel (nickel plating, white zinc plating, color zinc plating)				
Chemical properties	Varies depending on the surface treatment (see Table 2)	Ordinary stainless steel, screws are not corrosion resistant	Heat treatment enhances physical properties and general corrosion resistance!	Air corrosion resistance	Fresh water corrosion resistance	Seawater corrosion resistance

Note: Features of stainless steel:

Stainless steel 201 is a nickel-saving stainless steel, which has the characteristics of beautiful appearance and corrosion resistance, but does not have the characteristics of high temperature resistance.

Stainless steel 304 features: 304 stainless steel is a universal stainless steel material, and its anti-rust performance is stronger than that of 200 series stainless steel materials. The high temperature resistance is also better, and the general use temperature limit is less than 650°C. 304 stainless steel has excellent corrosion resistance and intergranular corrosion resistance. For oxidizing acids, it is found in experiments that 304 stainless steel has strong corrosion resistance in nitric acid with a concentration below 65% boiling temperature. It also has good corrosion resistance to alkali solutions and most organic and inorganic acids.

Stainless steel 316 features: corrosion resistance is better than 304 stainless steel, and it has good corrosion resistance. Moreover, 316 stainless steel is also resistant to marine and aggressive industrial atmosphere.

316 stainless steel has good oxidation resistance in intermittent use below 871 °C (1600 F°) and continuous use below 927 °C (1700 F°).

1. American Hose Clamp

Principles and characteristics:

Stainless steel American hose clamps, steel strips arranged in rectangular through holes, have the characteristics of sealing no dead corners, balanced torsion torque and unlimited length, can be easily used in in some large outdoor equipment binding. If it is used on smaller objects, it has the characteristics of convenient installation and low maintenance cost. Therefore, the range of American hose clamps is very wide. Moreover, because of the strong flexibility of the American hose clamp steel belt, it can be effectively used on non-circular objects and square cylindrical objects, such as smoke exhaust pipe and outdoor steel structures, which are unmatched by other hose clamps.

Big American hose clamp

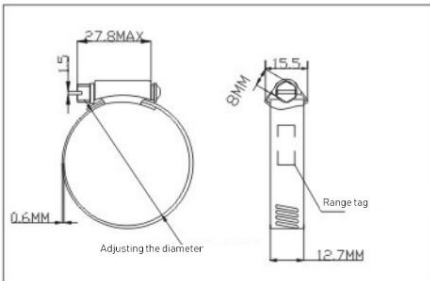

Bandwidth (mm)	Range (mm)	Range (inch)	Thickness (mm)	Break torque (Nm)
8	8-12	3/8-1/2"	0.6	5Nm
8	10-16	3/8-0.629"	0.6	5Nm
8	13-19	1/2-3/4"	0.6	5Nm
8	11-20	0.44-0.78"	0.6	5Nm
8	14-27	0.56-1.06"	0.6	5Nm
12.7	18-32	0.69-1.25"	0.6	8Nm
12.7	21-38	0.81-1.5"	0.6	8Nm
12.7	21-44	0.81-1.75"	0.6	8Nm
12.7	27-51	1.06-2.0"	0.6	8Nm
12.7	33-57	1.31-2.25"	0.6	8Nm
12.7	40-64	1.56-2.5"	0.6	8Nm
12.7	52-76	2.06-3"	0.6	8Nm
12.7	59-83	2.31-3.25"	0.6	8Nm
12.7	65-89	2.56-3.5"	0.6	8Nm
12.7	70-95	2.81-3.75"	0.6	8Nm
12.7	78-101	3.06-4"	0.6	8Nm
12.7	90-114	3.56-4.5"	0.6	8Nm
12.7	105-127	4.06-5.5"	0.6	8Nm
12.7	117-140	4.62-5.5"	0.6	8Nm
12.7	130-152	5.12-6"	0.6	8Nm
12.7	141-165	5.56-6.5"	0.6	8Nm
12.7	153-178	6.18-7"	0.6	8Nm

Medium American hose clamp



Small American hose clamp

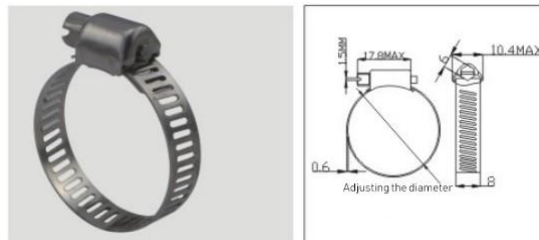

German Hose Clamp Turbine and vortex rod hose clamp series

2. German Hose Clamp

Principles and characteristics:

All kinds of steel strips used in the production of Btek stainless steel hose clamps have been rounded, which can effectively ensure that they will not hurt your hands during production and use! German hose clamp, also called non-perforated hose clamp, its flanging design and non-perforated structure can effectively ensure that the surface of the flexible silicone tube and other hose surface are not damaged.

	<p>German hose clamp has blanking edge design and no perforation, which effectively protects the surface of the hose</p>		<p>Conventional American has a style without flanging</p>
---	--	---	---

German 9mm wide



Bandwidth (mm)	Range (mm)	Range (inch)	Thickness (mm)	Break torque (Nm)
9	8-12	0.31-0.47"	0.6	5Nm
9	10-16	3/8-5/8"	0.6	5Nm
9	12-20	0.49-3/4"	0.6	5Nm
9	16-27	5/8-1.0"	0.6	5Nm
9	20-32	25/32-11/4"	0.6	5Nm
9	25-40	0.98-1.57"	0.6	5Nm
9	30-45	11/4-2.0"	0.6	5Nm
9	32-50	11/4-2.0"	0.6	5Nm
9	40-60	19/16-2.36"	0.6	5Nm
9	50-70	2-3/4"	0.6	5Nm
9	60-80	2.36-3.15"	0.6	5Nm
9	70-90	2.34-3.54"	0.6	5Nm
9	80-100	3.15-3.94"	0.6	5Nm
9	90-110	3.54-4.33"	0.6	5Nm
9	100-120	3.94-4.72"	0.6	5Nm
9	110-130	4.33-5.12"	0.6	5Nm
9	120-140	4.72-5.51"	0.6	5Nm
9	130-150	5.12-5.91"	0.6	5Nm
9	140-160	5.51-6.3"	0.6	5Nm
9	150-170	5.91-6.69"	0.6	5Nm
9	160-180	6.3-7.09"	0.6	5Nm

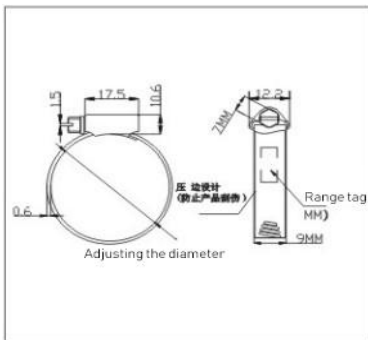

Description:

The 9MM wide and small German type hose clamp is an ideal choice for small diameter hoses. The manufacture of the turbine vortex rod hoop seat adopts computer-controlled fully automated welding, and the bottom welding seam of the hoop seat is closely matched. It can be used in a wide range, even the smallest hose can ensure roundness and sealing.

German 12mm wide



German head tilt

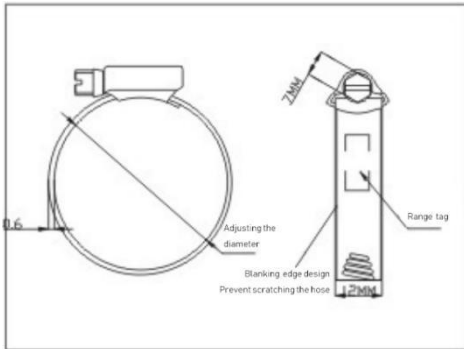

Bandwidth (mm)	Range (mm)	Range (inch)	Thickness (mm)	Break torque (Nm)
12	12-20	0.49-3/4"	0.6	5Nm
12	16-27	5/8-1.0"	0.6	5Nm
12	20-32	25/32-1 1/4"	0.6	5Nm
12	25-40	0.98-1.57"	0.6	5Nm
12	30-45	1 1/4-2.0"	0.6	5Nm
12	35-50	1.38-2"	0.6	5Nm
12	40-60	19/16-2.36"	0.6	5Nm
12	50-70	2-3/4"	0.6	5Nm
12	60-80	2.36-3.15"	0.6	5Nm
12	70-90	2.34-3.54"	0.6	5Nm
12	80-100	3.15-3.94"	0.6	5Nm
12	90-110	3.54-4.33"	0.6	5Nm
12	100-120	3.94-4.72"	0.6	5Nm
12	110-130	4.33-5.12"	0.6	5Nm
12	120-140	4.72-5.51"	0.6	5Nm
12	130-150	5.12-5.91"	0.6	5Nm
12	140-160	5.51-6.3"	0.6	5Nm
12	150-170	5.91-6.69"	0.6	5Nm
12	160-180	6.3-7.09"	0.6	5Nm
12	170-190	6.69-7.48"	0.6	5Nm

British Hose Clamp Turbine and vortex rod hose clamp series

3. British Hose Clamp

Principles and characteristics:

The British hose clamp has a special and firm hoop seat system. The rolled hoop with smooth inner steel band and inner surface can effectively protect the soft hose from abrasion. BTEK British hose clamp has high clamping force and high breaking torque, which is the safest and most reliable clamp. The British hose clamp steel belt has a thickness of 1mm, which is the thickest of turbine vortex clamp family. The strong hoop is the first choice for various heavy-duty high-pressure waterways! British 11.7mm wide



Bandwidth (mm)	Range (mm)	Range (inch)	Thickness (mm)	Break torque (Nm)
9.7	9-13	3/8-1/2"	1	5Nm
9.7	13-16	1/2-0.629"	1	5Nm
9.7	13-19	1/2-3/4"	1	5Nm
11.7	16-22	0.629-7/8"	1	5Nm
11.7	19-25	3/4-1"	1	5Nm
11.7	22-29	7/8-1 1/4"	1	7Nm
11.7	25-38	1-1 3/8"	1	7Nm
11.7	28-41	7/8"-1.6"	1	7Nm
11.7	31-48	1 1/4-1.89"	1	7Nm
11.7	38-54	1 1/2-2 1/16"	1	7Nm
11.7	44-60	1.737-2.36"	1	7Nm
11.7	50-70	2-2 3/4"	1	7Nm
11.7	60-80	1.737-3 3/8"	1	7Nm
11.7	70-90	2 3/4-3 1/2"	1	7Nm
11.7	83-102	1.737-4"	1	7Nm
11.7	95-115	3.7-4.52"	1	7Nm
11.7	104-127	4-5"	1	7Nm
11.7	127-146	5-6"	1	7Nm

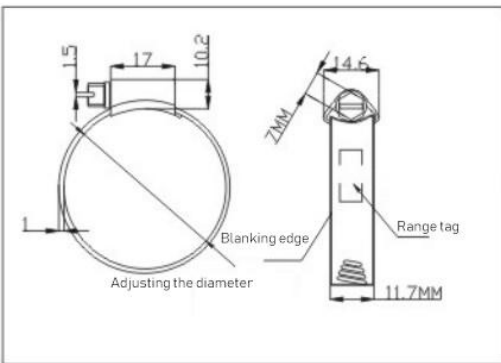

British 9.7mm wide



Carbon Steel English for Punching



Stainless steel for milling

Usage photos

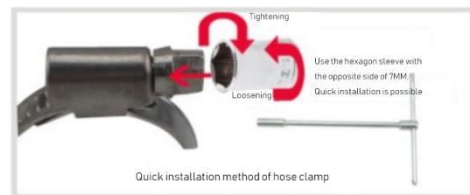

Note: Please refer to [page 12](#) for the specific introduction of installation tools

Spring Clamp Quick installation hose clamp series

Installation takes only two seconds, which greatly improves production efficiency!

Inner diameter optimization (mm) D	Non optimal D (mm)	Material thickness (mm) T	Width (mm) d
φ7	7.5	0.6	6
φ8	8.5	0.8	8
φ9	9.5	0.8	8
φ10	10.5	0.8	8
φ11	11.5	0.8	8
φ12	12.5	0.8	8
φ13	13.5	0.8	10
φ14	14.5	0.8	10
φ15	15.5	1	10
φ16	16.5	1	10
φ17	17.5	1	10
φ18	18.5	1	10
φ19	19.5	1	10
φ20	20.5	1.2	12
φ20	20.5	1.5	15
φ21	21.5	1.5	15
φ22	22.5	1.5	15
φ23	23.5	1.5	15
φ24	24.5	1.5	15
φ25	25.5	1.5	15
φ28	28.5	1.5	15
φ30	30.5	1.5	15

1.Spring Clamp

This clamp abandons the principle of screw locking used by other hose clamps, and realizes the clamping function by excavating the unique elasticity of spring steel. Exquisite selection of materials, excellent heat treatment, deepening of surface treatment, select excellent 65MN materials, from the test of the incoming material to the temperature control of the heat treatment after the finished product, so as to play the maximum elasticity of this material! In this link, the clamp brittleness and elasticity tests are particularly important. Our company has reached the standard one by one. Finally, the clamp is subjected to strict surface treatment. Surface treatment, in order to achieve the best performance, decoration performance, and corrosion resistance, must be brought to the extreme!

Spring Clamp

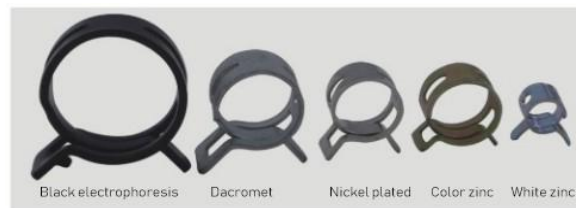
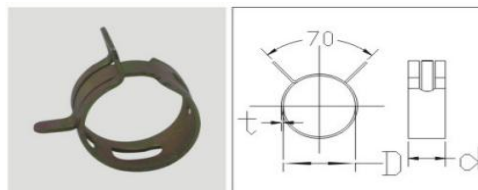

Compared with other hose clamps, the hose clamp is more convenient to install. It only takes 2 seconds, which is more accurate and greatly improves production efficiency and saves production costs.

Note: This hose clamp has no adjustment range! The specification refers to the natural inner diameter (i.e. D) before the clamp is installed. If the specifications you need are not in the above table, our company can also customize it!

Tolerance: such as the 12.5 standard, the actual measurement data of the finished product is between 12.3-12.45, and so on.

Comparison table of various surface treatments (2)

Surface treatment	Colorful zinc	White zinc	Blue and white zinc	Nickel plated	Dacromet	Electrophoresis
Features	Strong rust resistance, the surface is not easy to oxidize and the color is dim	High uniformity, environmental protection, low cost and wide use	High uniformity, environmental protection, low cost and wide use	The crystal is fine, smooth and bright, the internal stress is small, the wear resistance is enhanced, and the friction coefficient is small	Extremely strong corrosion resistance, salt spray test can reach 1000 hours	Strong decoration, no sagging, thicker edges and pitting
Cost	Low	Low	Low	Higher	Higher	Higher

Note: This table is applicable to some carbon steel clamps

Usage of spring clamp



Elasticity test, repeated clamping can be restored to the original state

Usage of single ear clamp

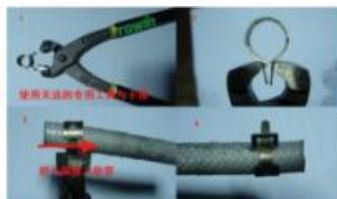

Refer to [page 12](#) for installation tools

Single Ear Clamp/ Double Ear Clamp Quick installation hose clamp series

2. Single Ear Clamp

1. Features: narrow band design: more concentrated clamping force, lighter weight control, and less interference
2. 360° stepless design: the hose surface is uniformly compressed, and 360° sealing guarantee
3. Ear width: the deformation size can compensate the hose hardware tolerance and adjust the surface pressure to control the clamping effect
4. Cochlear design: provides a strong thermal expansion compensation function, and the dimensional change of the hose due to temperature changes can be compensated, so that the pipe is always in a good sealed and fastened state
5. Special treatment of the edge grinding process: avoid hose damage and ensure tooling safety



Single Ear Clamp

1. Specification table of small single ear clamp (bandwidth 5MMX0.5 thickness)

Model	D		Adjustment range		Reference clamping force (N)
	Millimeter	Inch	Millimeter	Inch	
S5065	6.5	.256	5.3-6.5	.209-.256	1000
S5070	7.0	.278	5.8-7	.228-.276	1000
S5075	7.5	.295	6.3-7.5	.248-.295	1000
S5080	8.0	.315	6.8-8.0	.268-.315	1000
S5087	8.7	.343	7.0-8.7	.276-.343	1000
S5090	9.0	.354	7.3-9.0	.287-.354	1000
S5095	9.5	.374	7.8-9.5	.307-.374	1000
S5100	10.0	.394	8.3-10.0	.327-.394	1000
S5105	10.5	.413	8.8-10.5	.346-.413	1000
S5109	109.0	.429	9.2-10.9	.362-.429	1000
S5113	11.3	.445	9.6-11.3	.378-.445	1000
S5118	11.8	.455	10.1-11.8	.395-.465	1000

2. Specifications table of ordinary single ear clamp (bandwidth 7MMX0.6 thickness)

Model	D		Adjustment range		Reference clamping force (N)
	Millimeter	Inch	Millimeter	Inch	
S7119	11.9	.460	9.4-11.9	.370-.469	2100
S7123	12.3	.484	9.8-12.3	.386-.484	2100
S7128	12.6	.504	10.3-12.8	.406-.504	2100
S7133	13.3	.524	10.3-13.3	.425-.524	2100
S7138	13.8	.543	11.3-13.8	.445-.543	2100
S7140	14.0	.551	11.5-14.0	.453-.551	2100
S7142	14.2	.559	11.7-14.2	.461-.559	2100
S7145	14.5	.571	12.0-14.5	.472-.571	2100
S7148	14.8	.583	12.3-14.8	.484-.583	2100
S7153	15.3	.602	12.8-15.3	.504-.602	2100
S7157	15.7	.618	13.2-15.7	.520-.618	2100
S7160	16.0	.630	13.5-16.0	.531-.630	2100
S7162	16.2	.638	13.7-16.2	.539-.638	2100
S7166	16.6	.654	14.1-16.6	.555-.654	2100

3. Enhanced single ear clamp (bandwidth 9MM, thickness 0.8MM)

Model	D		Adjustment range		Reference clamping force (N)
	Millimeter	Inch	Millimeter	Inch	
S9241	24.1	.949	20.9-24.1	.823-.949	4100
S9301	30.1	1.185	26.9-30.1	1.059-1.185	4100
S9316	31.6	1.244	28.4-31.6	1.118-1.244	4100
S9331	33.1	1.303	29.9-33.1	1.177-1.303	4100
S9346	34.6	1.362	31.4-34.6	1.236-1.362	4100
S9361	36.1	1.421	32.9-36.1	1.295-1.421	4100
S9376	37.6	1.480	34.4-37.6	1.354-1.480	4100
S9410	41.0	1.614	37.8-41.0	1.488-1.614	4100
S9425	42.5	1.673	39.3-42.5	1.547-1.673	4100
S9440	44.0	1.732	40.8-44.0	1.606-1.732	4100
S9470	47.0	1.850	43.8-47.0	1.724-1.850	4100
S9485	48.5	1.909	45.3-48.5	1.783-1.909	4100
S9530	53.0	2.087	49.8-53.0	1.961-2.087	4100

4. Strong single ear clamp (bandwidth 10MM, thickness 1MM)

Model	D		Adjustment range		Reference clamping force (N)
	Millimeter	Inch	Millimeter	Inch	
S10815	81.5	3.209	76.3-81.5	3.083-3.209	7000
S10835	83.5	3.287	83.3-83.5	3.161-3.287	7000
S10888	88.8	3.496	85.6-88.8	3.370-3.496	7000
S10896	89.6	3.628	86.4-89.6	3.402-3.528	7000
S10925	92.5	3.642	89.3-92.5	3.518-3.642	7000
S10954	95.4	3.756	92.2-95.4	3.630-3.756	7000
S10965	96.5	3.800	93.3-96.5	3.673-3.800	7000
S10995	99.5	3.917	96.3-99.5	3.791-3.917	7000
S10998	99.8	3.929	96.6-99.8	3.803-3.929	7000
S101008	100.8	3.969	97.6-100.8	3.843-3.969	7000
S101062	106.3	4.185	103.1-106.3	4.059-4.201	7000
S101067	106.7	4.201	103.5-108.7	4.075-4.201	7000
S101150	115.0	4.528	111.8-115.0	4.402-4.528	7000

Installation method:

Put the hose on the our single ear stepless clamp, then put the hose into the joint, place the clamp in the correct position, and then use our special calipers to clamp the clamp ears. If the space is not allowed, use side cutters. After installation, the two sides of the ears of the hose clamp should be kept at a small and appropriate distance.

If the two ears contact after installation, it means that the size is larger, and the smaller one should be selected. If the clamp is broken during the installation process, it means that the hose clamp is small and the larger one should be used. Our single ear clamp provides a convenient, safe and effective hose fastening technology.

In order to install the our single-ear clamp more appropriately, the selection is a very important work. Therefore, our company sets up a specification almost every 0.2MM. The recommended installation dimensions are shown in the table.

Double Ear Clamp

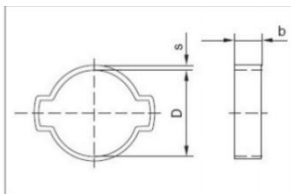

Clamp specifications(D)	b	s
5-7*	6	0.6
7-9	6	0.8
9-11	6.5	0.8
11-13	6.5	0.9
13-15*	7	1
14-17	7	1.2
15-18*	7.5	1.2
17-20	7.5	1.2
18-21	8	1.2
20-23*	8	1.3
22-25*	8.5	1.4
23-27	8.5	1.4
25-28	9	1.4
28-31	9	1.4
31-34	9.5	1.4
34-37	9.5	1.6
37-40	10	1.6

Product description:

The ear-shaped clamp is made of high-quality seamless steel pipes, and the surface is high-quality electro-galvanized treatment. It has the characteristics of strong sealing, large clamping force, and not easy to loosen. It is widely used in oxygen transmission and the fastening of liquid pipeline joints.

Surface treatment types: white zinc plating, color zinc plating, nickel plating, and other surface treatments.

European Strength /T Strength Strong fastening technology

1.Strong hose clamp

European strength, large volume and strong torque. It is widely used in some places with strong requirements for the fastening force of thick-walled hoses, and the possibility of looseness in use is very low.

European clamp welding adopts three-point convex welding so that the structure is very strong, and the edge of the steel belt protrudes outward to protect the surface of the hose.

European clamp model is connected through the board, so that the sealing effect can be perfectly exerted.

Single head solid strong hose clamp

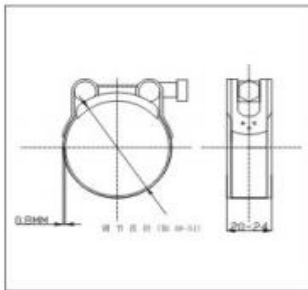

Range		Bolt	Thickness*width		Load torque (N)
mm	Inch		W1	W4	
17-19	0.67"-0.75"	M5*40	0.6*18	0.6*18	8.5Nm
20-22	0.79"-0.87"	M5*40	0.6*18	0.6*18	8.5Nm
23-25	0.91"-0.98"	M5*40	0.6*18	0.6*18	8.5Nm
26-28	1.02"-1.1"	M5*40	0.6*18	0.6*18	8.5Nm
29-31	1.14"-1.22"	M6*50	0.8*20	0.6*20	8.5Nm
32-35	1.26"-1.38"	M6*50	0.8*20	0.6*20	8.5Nm
36-39	1.42"-1.54"	M6*50	0.8*20	0.6*20	8.5Nm
40-43	1.57"-1.69"	M6*50	0.8*20	0.6*20	8.5Nm
44-47	1.73"-1.85"	M6*55	1.2*22	0.8*22	8.5Nm
48-51	1.98"-2"	M6*55	1.2*22	0.8*22	8.5Nm
52-55	2.05"-2.17"	M6*55	1.2*22	0.8*22	8.5Nm
56-59	2.2"-2.32"	M6*55	1.2*22	0.8*22	8.5Nm
60-63	2.36"-2.48"	M6*55	1.2*22	0.8*22	8.5Nm
64-67	2.52"-2.64"	M6*55	1.2*22	0.8*22	8.5Nm
68-73	2.68"-2.87"	M8*70	1.5*24	0.8*24	8.5Nm
74-79	2.91"-3.11"	M8*70	1.5*24	0.8*24	8.5Nm
80-85	3.15"-3.35"	M8*70	1.5*24	0.8*24	8.5Nm
86-91	3.39"-3.58"	M8*70	1.5*24	0.8*24	8.5Nm
92-97	3.62"-3.82"	M8*70	1.5*24	0.8*24	8.5Nm
98-103	3.86"-4.06"	M8*75	1.5*24	0.8*24	8.5Nm
104-112	4.09"-4.41"	M8*75	1.5*24	0.8*24	8.5Nm
113-121	4.45"-4.76"	M8*75	1.5*24	0.8*24	8.5Nm
122-130	4.8"-5.12"	M8*75	1.5*24	0.8*24	8.5Nm
131-139	5.16"-5.47"	M10*85	1.7*26	1.0*26	8.5Nm
140-148	5.51"-5.83"	M10*85	1.7*26	1.0*26	8.5Nm
149-161	5.87"-6.34"	M10*85	1.7*26	1.0*26	8.5Nm
162-174	6.4"-6.85"	M10*85	1.7*26	1.0*26	8.5Nm
175-187	6.9"-7.4"	M100*100	1.7*26	1.0*26	8.5Nm
188-200	7.4"-7.87"	M100*100	1.7*26	1.0*26	8.5Nm
201-213	7.87"-8.4"	M100*100	1.7*26	1.0*26	8.5Nm
214-226	8.4"-8.9"	M100*100	1.7*26	1.0*26	8.5Nm
227-239	8.9"-9.4"	M100*100	1.7*26	1.0*26	8.5Nm
240-252	9.5"-10"	M100*100	1.7*26	1.0*26	8.5Nm

T strong hose clamp



T-bolt hose clamp is designed for non-leakage connection, and the edge of the steel belt has been rounded to protect the hose.

Double head solid strong hose clamp



Tiger clamp strong hose clamp



Special strong hose clamp



2. Mini clamp

Range	Thickness	width
mm	mm	mm
6-8	9	0.6mm
7-9	9	0.6mm
8-10	9	0.6mm
9-11	9	0.6mm
10-12	9	0.6mm
11-13	9	0.6mm
12-14	9	0.6mm
13-15	9	0.6mm
14-16	9	0.6mm
15-17	9	0.6mm
16-18	9	0.6mm
17-19	9	0.6mm
18-20	9	0.6mm
19-21	9	0.6mm
20-22	9	0.6mm
21-23	9	0.6mm
22-24	9	0.6mm
23-25	9	0.6mm
24-26	9	0.6mm
25-27	9	0.6mm
26-28	9	0.6mm
27-29	9	0.6mm
28-30	9	0.6mm
29-31	9	0.6mm
30-32	9	0.6mm
31-33	9	0.6mm
32-34	9	0.6mm

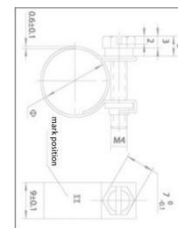

Product description:

The edge of the band rolled up by the mini clamp can protect the hose. Increase the strength to the side of the hose at the opening of the cuff. If the bolt is screwed, the nut will not rotate. And the hexagonal sleeve tool provided by us can be used to screw the hexagonal bolt. Mini clamps especially use small-sized thin-walled hoses.

Steel Wire Strong Hose Clamp Strong fastening technology

3. Steel wire strong

Principles and characteristics:

The biggest difference between the double-wire hose clamp and other hose clamps is that two steel wires are used as the fastening carrier, and the steel wires are used to fasten the smaller load-carrying area, which can concentrate the pressure on one working surface. So as to make the logistics more firmly bound. However, the double steel wire hose clamp remains the same as the strong hose clamp, they both use the triangular thread transmission principle of screws and nuts, the material selection of the double steel wire hose clamp is stricter.

Double wire hose clamp

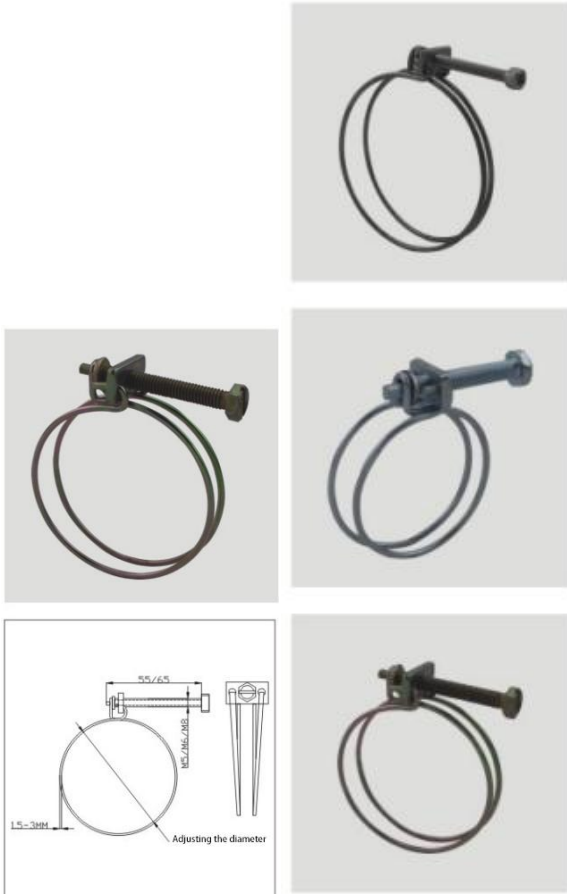

NOTE: W1-all iron galvanized
W4-all 200ss, 300ss stainless steel

Range		wire diameter	screw size	Load torque
mm	Inch	mm	mm	(N)
8-12	0.31"-0.47"	1.5	M5*35	5-7Nm
11-14	0.43"-0.55"	1.5	M5*35	5-7Nm
13-16	0.51"-0.63"	1.5	M5*35	5-7Nm
15-18	0.59"-0.71"	1.5	M5*35	5-7Nm
17-20	0.67"-0.79"	1.8	M5*35	5-7Nm
19-22	0.75"-0.87"	1.8	M5*35	5-7Nm
20-24	0.79"-0.94"	1.8	M5*35	5-7Nm
22-26	0.87"-1.02"	1.8	M5*35	5-7Nm
24-28	0.94"-1.1"	1.8	M5*35	5-7Nm
26-30	1.02"-1.18"	2	N6*40	5-7Nm
28-32	1.1"-1.26"	2	N6*40	5-7Nm
31-35	1.22"-1.38"	2	N6*40	5-7Nm
34-38	1.34"-1.5"	2	M6*50	5-7Nm
35-40	1.38"-1.57"	2.5	M6*50	5-7Nm
37-42	1.46"-1.65"	2.5	M6*50	5-7Nm
40-45	1.57"-1.77"	2.5	M6*50	5-7Nm
43-48	1.69"-1.89"	2.5	M6*50	5-7Nm
45-50	1.77"-1.97"	2.5	M6*50	5-7Nm
47-52	1.85"-2.05"	2.5	M6*50	5-7Nm
50-55	1.97"-2.17"	2.5	M6*50	5-7Nm
53-58	2.09"-2.28"	2.5	M6*50	5-7Nm
55-60	2.17"-2.36"	2.5	M6*60	5-7Nm
54-62	2.13"-2.44"	2.5	M6*60	5-7Nm
60-65	2.36"-2.56"	2.5	M6*60	5-7Nm
63-68	2.48"-2.68"	3	M6*60	5-7Nm
65-70	2.56"-2.76"	3	M6*60	5-7Nm
70-75	2.76"-2.95"	3	M6*60	5-7Nm
75-80	2.95"-3.15"	3	M6*60	5-7Nm
80-85	3.15"-3.35"	3	M6*60	5-7Nm
84-90	3.31"-3.54"	3	M6*60	5-7Nm
89-95	3.5"-3.74"	3	M6*60	5-7Nm
94-100	3.7"-3.94"	3	M6*60	5-7Nm
98-105	4.06"-4.33"	3	M6*60	5-7Nm
103-110	4.45"-4.72"	3	M6*60	5-7Nm

	Single package	Bagged	Carton	Shipment
sold inside the country				
export sales				

Tape and Bundle Clamp

The principle and characteristics of the tape:

The main feature of this rubber pad clamp is to protect the rigid pipes, hoses and cables which need to be fixed. The rubber pad has the ability of avoiding vibration during exercise, anti-friction and insulation function.

Tape clamp

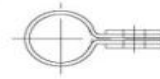
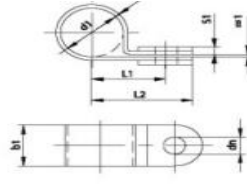

Galvanized wire card with glue

A1

B1

C1

Range	b1	b2	dn	d3	L1	L2 MAX	L3	L4 MAX	L5	L6 MAX	L7	L8 MAX	S1 W1	W2	S2 W1	W2	S3									
40-20	9	13	4.3	d1+	5.2	d1/2+	4.7	d1/2+	9.2	d1/2+	5.7	d1/2+	10.2	d1/2+	4.7	d1/2+	9.2	d1/2+	5.7	d1/2+	10.2	0.4	0.4	1.4	1.4	1
4-25	12	15	5.3	d1+	5.8	d1/2+	6.8	d1/2+	13	d1/2+	8	d1/2+	14	d1/2+	6.8	d1/2+	13	d1/2+	8	d1/2+	14	0.5	0.5	1.5	1.5	1.2
5-14	15	19	6.4	d1+	7.4	d1/2+	9.7	d1/2+	17.2	d1/2+	11.2	d1/2+	18.7	d1/2+	9.7	d1/2+	17.2	d1/2+	11.2	d1/2+	18.7	0.5	0.6	1.6	1.6	1.5
15-46	15	19	6.4	d1+	7.4	d1/2+	9.7	d1/2+	17.2	d1/2+	11.2	d1/2+	18.7	d1/2+	9.7	d1/2+	17.2	d1/2+	11.2	d1/2+	18.7	0.8	0.6	1.8	1.6	1.5
10-25	20	25	8.4	d1+	9	d1/2+	12.5	d1/2+	22.5	d1/2+	14.5	d1/2+	24.5	d1/2+	12.5	d1/2+	22.5	d1/2+	14.5	d1/2+	24.5	0.8	0.8	2.3	2.3	2
26-25	20	25	8.4	d1+	9	d1/2+	12.5	d1/2+	22.5	d1/2+	14.5	d1/2+	24.5	d1/2+	12.5	d1/2+	22.5	d1/2+	14.5	d1/2+	24.5	1	0.8	2.5	2.3	2
15-49	25	31	10.5	d1+	13	d1/2+	14.5	d1/2+	27	d1/2+	17.5	d1/2+	30	d1/2+	14.5	d1/2+	27	d1/2+	17.5	d1/2+	30	1	1	2.3	2.3	3
50-150	25	31	10.5	d1+	13	d1/2+	14.5	d1/2+	27	d1/2+	17.5	d1/2+	30	d1/2+	14.5	d1/2+	27	d1/2+	17.5	d1/2+	30	1.25	1.25	2.75	2.5	3

Common specifications and dimensions

mm	inch
DN40	1.5"
DN50	2"
DN75	3"
DN100	4"
DN125	5"
DN150	6"
DN200	8"
DN250	10"
DN300	12"

Flexible pipe clamp for cast iron pipe

W tube bundle product description:

With the rapid development of the construction industry, the number of high-rise buildings is increasing, and higher requirements for the quality of the drainage pipe system are put forward. The flexible interface cast iron pipe drainage system is becoming more and more widely recognized due to its advanced production technology and superior performance. The stainless steel pipe east series product is an essential part of the flexible cast iron pipe connection. The crystal is made of high-quality stainless steel material, equipped with special rubber rings with good performance, and has the characteristics of beautiful appearance, convenient installation, strong durability and good seismic resistance

B tube bundle	C tube bundle	F tube bundle	E tube bundle	G tube bundle
---------------	---------------	---------------	---------------	---------------









Installation instructions



Installation Tools and Other Clamps







BTEK other hose clamp products

Building decoration	 Sling tube clamp	 Pipe clamp with nail	 Ohmic clamp (wire clamp)	
Maintenance MRO	 Hose clamp	 American hose clamp set	 Welding rod	 U clamp
Automobile industry	 Exhaust pipe clamp	 American anti-vibration hose clamp	 Wire clamp	 Air conditioner hose clamp
Other industries	 Stainless steel cable tie	 Quick release hose clamp	 Belt pulling hose clamp	 Groove clamp
Plastic hose clamp		<ol style="list-style-type: none"> 1. The operation is simple and quick, the disassembly is convenient, the work efficiency is high, and can save 10 times installation time. 2. The strength is equivalent to that of stainless steel hose clamps; the tightening force can even exceed that of metal hose clamps. 3. Good sealing, no dead corner, corrosion resistance, high temperature resistance, no sliding, no conductive, and no corrosive. 4. High cost performance: the price is only 1/3 of that of metal products, and it has a long service life and can be reused. 		

Do our best to meet customer needs!

If you need to purchase such products, please provide the crystal name and usage description, etc. Our company will provide more detailed parameters and samples.

List of installation tools for hose clamps

Single ear clamp Special tools for spring clamps	Torque wrench	Single ear clamp automatic assembly tool	Lock wrench	Inner hexagonal socket set	Screwdriver
					
Used for small batch installation of clamps, low purchase cost and large workload	Can accurately calculate the torque required for installation	Used for large batch installation of clamps, high purchase cost, small workload, easy installation	Special for plastic hose clamp installation	The opposite side 7MM and 8MM sleeves are specially used for quick manual installation of German and American hose clamps	Suitable for small batch installation of all slotted screw hose clamps

Clamp Weight and Packaging Size

Appendix (1)

Weight of part of hose clamp (kg/piece)

Model	American W	American W2	German W4	German W1	British W4	British W1	Single ear (g/piece)	
8-12	0.0058	0.0055	0.011	0.0121	0.001	0.001	5.3-6.5	0.82
10-16	0.0060	0.0058	0.0113	0.0142	0.0106	0.0104	5.8-7.0	0.885
13-19	0.0065	0.0060	0.0119	0.0156	0.0123	0.0119	6.8-8.0	0.92
16-25	0.0068	0.0065	0.0125	0.0175	0.0135	0.0133	7.0-8.7	1.032
22-32	0.0204	0.0175	0.0149	0.0179	0.0212	0.021	7.3-9.0	0.98
25-38	0.0212	0.0181	0.0153	0.0182	0.0227	0.0232	7.8-9.5	1.098
32-44	0.022	0.02	0.0163	0.0192	0.0238	0.0256	8.3-10.0	1.03
35-51	0.023	0.0208	0.0172	0.0197	0.0281	0.0277	8.8-10.5	1.08
38-57	0.024	0.0217	0.0178	0.0203	0.0322	0.0303	9.2-10.9	1.10
44-64	0.026	0.0232	0.02	0.0217	0.033	0.0312	9.6-11.3	1.20
51-70	0.027	0.0243	0.0205	0.0232	0.0344	0.0357	10.1-11.8	1.23
64-76	0.0285	0.0256	0.021	0.0247	0.0370	0.0370	9.4-11.9	2.39
70-89	0.030	0.027	0.0227	0.0269	0.0416	0.04	9.8-12.3	2.41
76-92	0.031	0.0285	0.023	0.0272	0.0425	0.0434	10.3-12.8	2.44
80-100	0.0322	0.0294	0.0238	0.0277	0.0217	0.0425	10.8-13.3	2.47
90-110	0.033	0.0312	0.0256	0.0312	0.0476	0.0465	11.3-13.8	2.50
100-120	0.035	0.032	0.0263	0.033	0.050	0.0476	11.5-14.0	2.52
110-130	0.037	0.0334	0.0277	0.0344	0.052	0.0512	11.7-14.2	2.53

Appendix (2)

Packaging dimension table of some clamp products: (for reference)

Specifications	American, German		British		Single ear clamp		Spring clamp		
	Quantity	Size	Quantity	Size	Quantity	Size	Diameter	Quantity	Size
8-12	5000	38x27 x21	3000	39x29x22	5.3-6.5	38x27x12	φ 7	10000	36*27*18
10-16	2500	38x27 x21	2500	39x29x22	5.8-7.0	38x27x12	φ 8	10000	36*27*18
13-19	2500	38x 27 x21	2500	48x27x37	6.8-8.0	38x27x12	φ 9	10000	36*27*18
16-25	2000	38x27 x21	2000	42x27x25	7.0-8.7	38x27x12	φ 10	10000	36*27*18
22-32	1000	38x27 x24	1500	42x27x25	7.3-9.0	38x27x14	φ 11	5000	36*27*18
25-38	1000	38x 27 x24	1500	42x27x25	7.8-9.5	38x27x14	φ 12	5000	36*27*18
32-44	1000	38x27x 24	1000	42x27x25	8.3-10.0	38x27x14	φ 13	5000	36*27*18
35-51	500	38x27 x29	1000	45x28x28	8.8-10.5	38x27x14	φ 14	5000	36*27*18
38-57	500	38x 27 x29	1000	45x30x30	9.2-10.9	38x27x14	φ 15	5000	36*27*18
44-64	500	38x27 x34	1000	45x34x34	9.6-11.3	38x27x14	φ 16	5000	36*27*18
51-70	500	40x38x 29	1000	45x31x37	10.1-11.8	38x27x14	φ 17	3000	36*27*18
64-76	500	41 x32x33	1000	49x40x41	9.4-11.9	38x27x14	φ 18	3000	36*27*18
70-89	500	41 x32x33	1 000	49x40x46	9.8-12.3	38x27x14	φ 19	3000	36*27*18
76-92	500	41 x32x33	1 000	49x40x48	10.3-12.8	38x27x14	φ 20	3000	36*27*18

Hose clamp product customs code: 8414909090

National standard for hose clamp: Hose clamp, Standard Number: JB/T 8870-1999 Machinery Industry Standard